

Conduction pin (angle free) for surface mounting

FAL-0.6

- Male pin that can connect PC board at any angle with electrical conductivity
- Adaptive socket is FAC-0.6
- Material : Phosphor bronze
- Finish : Gold plating over nickel base
- Specification (In case of connect with FAC-0.6)
 Rated current : 10A
 Contact resistance : 20m Ω or less
 Insertion / removal durability : 100 cycles
 Operating temperature range : - 40 to +125℃

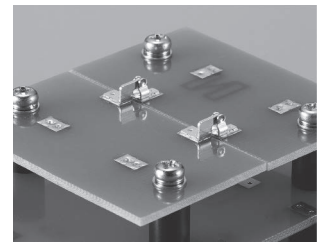
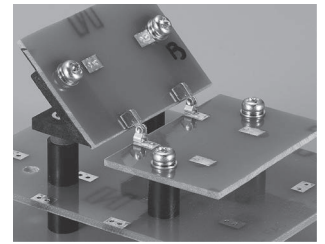
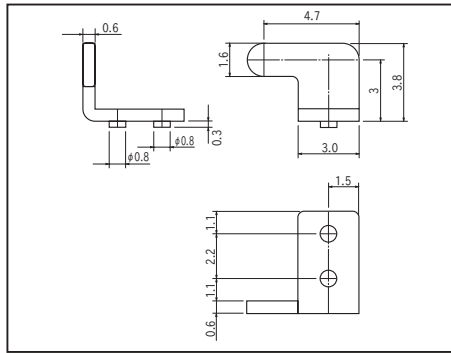

■ Part No.

Part No.	Package
FAL-0.6	Bulk (100pcs/pack)
FAL-0.6-T	Reel (250pcs/reel)

■ Recommended land information

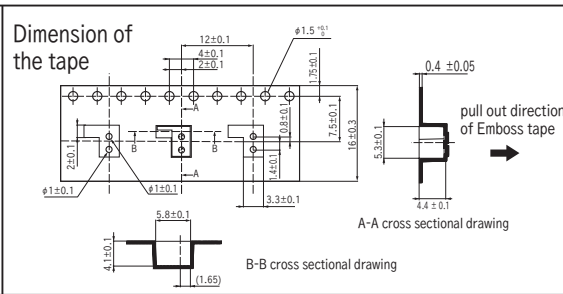
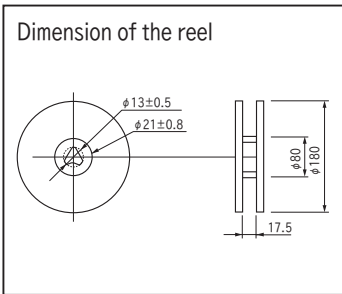
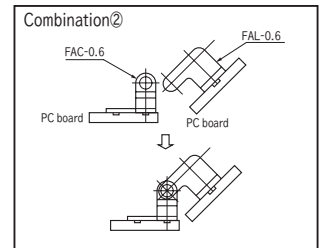
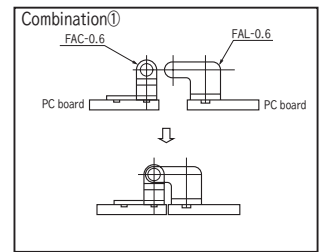
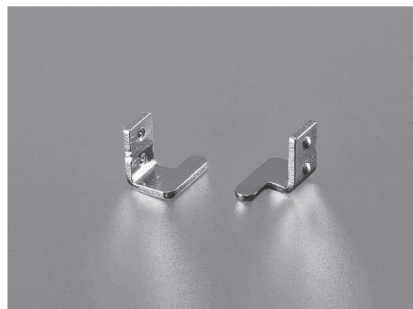
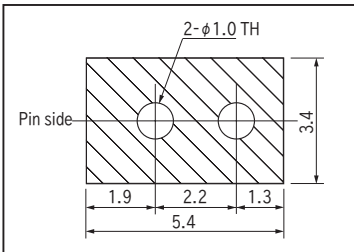

Conduction socket (angle free) for surface mounting

FAC-0.6

- By combining with FAL-0.6, PC board can be connected at any angle with electrical conductivity
- Material : Phosphor bronze
- Finish : Gold plating over nickel base

■ Recommended land information

■ Part no

Part No.	Package
FAC-0.6	Bulk (100pcs/pack)
FAC-0.6-T	Reel (250pcs/reel)

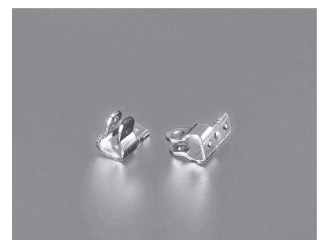
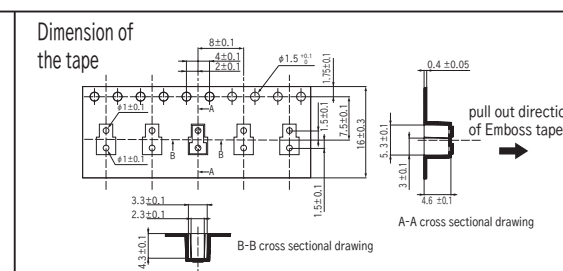
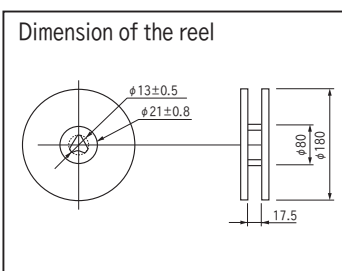
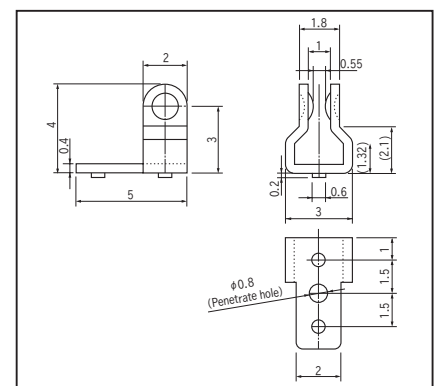
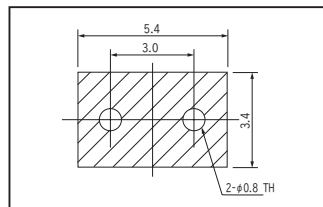

※ The main purpose is to conduct the product, not to fix 2 PC boards.